

WALL-MOUNT CHIMNEY RANGE HOOD

## Perimeter Vent Series

Model: EMS6008-CR

# FOTILE

A BREATH OF FRESH ENGINEERING®



## Features & Benefits



### High Efficiency DC Motor

- Industry Leading Technology.
- Powerful and efficient ventilation.
- Refreshes the whole kitchen in just minutes.

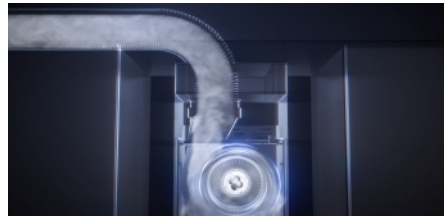

### High Max Static Pressure

- Automatic cruise booster automatically accelerates and pressurizes to deliver a maximum burst of 840Pa ventilation propulsion in quick response to flue obstructions.

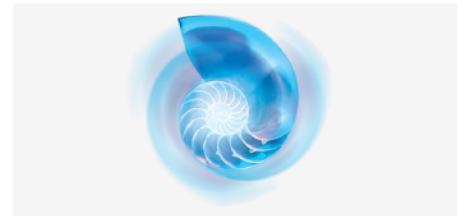

### Ultra-quiet Operation

- DC frequency conversion airflow sounds soft and natural Bionic impeller keeps airflow smooth and silent.
- Nautilus-shaped intake chamber reduces obstructions to fume extraction.

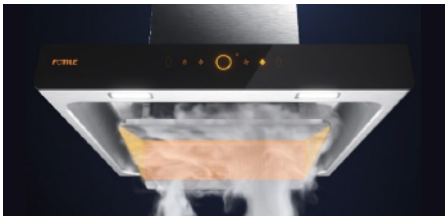

### Capture Shield Technology

- Cover wider cooking area.
- Create a "Coanda Effect" ensuring ultra-fast powerful ventilation.



### Simple to Clean

- Detachable Capture Shields with integrated oil cup.
- Dishwasher safe or hand clean with soap and water.



### Motion Gesture Activation

- Contact-less Touch Free Operation.
- Simply Wave to the range hood, and it will automatically Power On / Off with fan and lights.

WALL-MOUNT CHIMNEY RANGE HOOD

## Perimeter Vent Series

Model: EMS6008-CR

# FOTILE

A BREATH OF FRESH ENGINEERING®



Model	EMS6008-CR
Certification	ETL
Ventilation Type	Ductless
Product Dimensions(W×D×H)(inch)	23 7/16 x 20 9/16 x 29 9/16-35 11/16
Speed Setting	4 (Low & Middle & High & Boost)
Max. EQUIV. CFM	850*
Noise Level(dB)	44 / 53 / 55 / 58
Power Supply(V/Hz)	120/60
Input Power(W)	200
Motor	DC Motor
Illumination(W)	3W × 2 (LED)
Max. Static Pressure(Pa)	840
Delay Shutoff	5min
Oil Filtration Rate	95%
Odor Elimination Rate	97%
Operation	Touch Screen
Capture Shield	Fixed
Oil Filter & Oil Cup	Removable & Dishwasher Safe
Height Adjustable	N
Auto Smoke Detection	N
Intelligent Air Management	N
Auto Turbo	N
Installation	Wall-Mount / Under-Cabinet (optional)
Warranty	2-Year Labor   5-Year (Limited) Parts   Lifetime (Limited) Motors

\*FOTILE Equivalent CFM is a higher CFM rating due to our filterless technology that combines WhisPower Motors and Capture-Shield design. By utilizing this technology, FOTILE applies the Coanda Effect by accelerating smoke extraction and grease separation, and increasing our Capture Efficiency. This enables FOTILE to cover a larger cooktop surface (7.2 Sq Ft) and achieve a ~92% oil filtration rate, and ~98% odor elimination rate, keeping your kitchen smoke free and smelling fresh.

Product Dimensions

Unit: inch(mm)

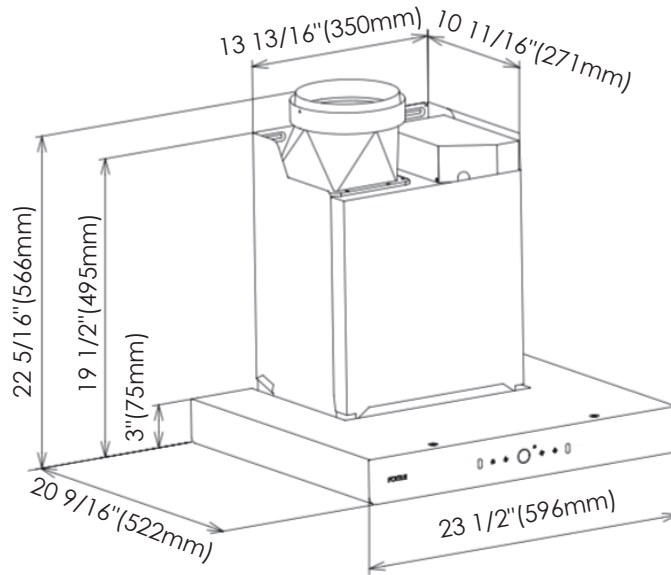

Installation Information

Unit: inch(mm)

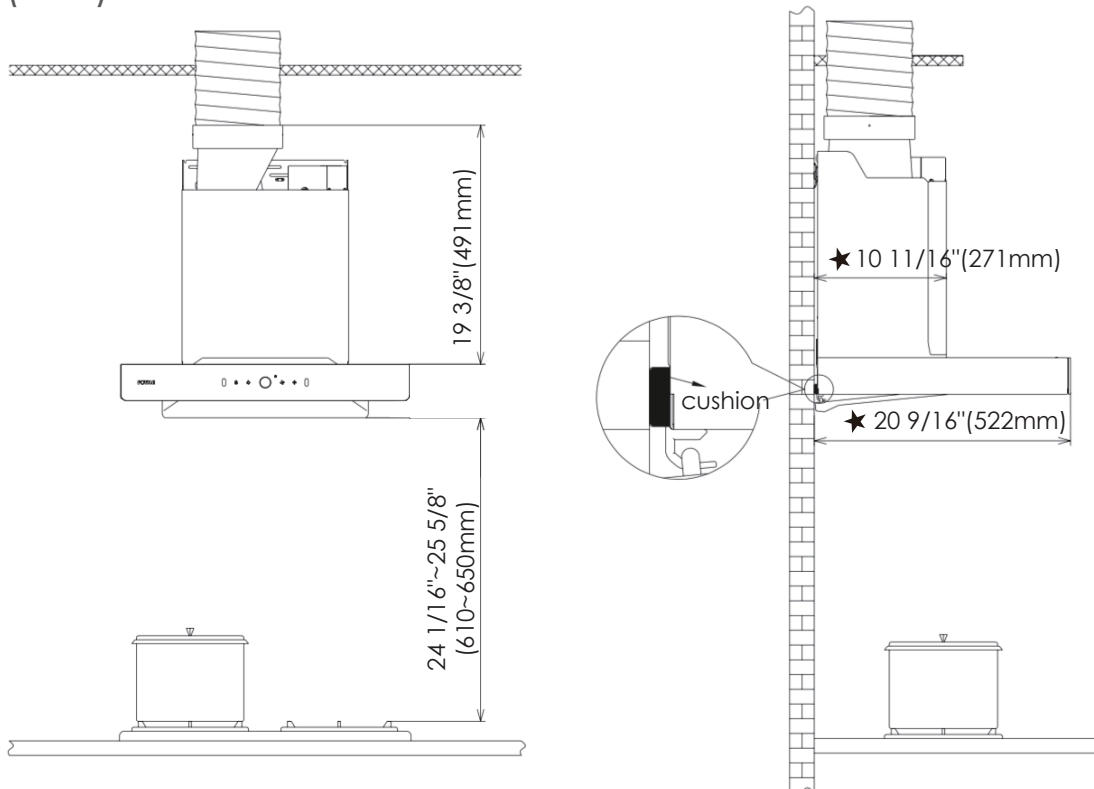

★ is the distance from the wall

WALL-MOUNT CHIMNEY RANGE HOOD

## Perimeter Vent Series

Model: EMS6008-CR

**FOTILE**

A BREATH OF FRESH ENGINEERING®

# Clean filtration for freshness you can smell

### Step 1

Capture Shield filters grease



### Step 2

Grease is trapped by the aluminum filter

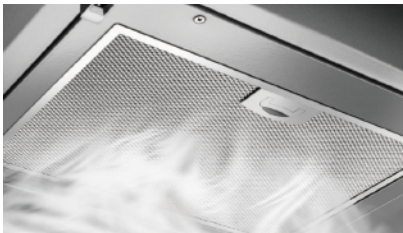

### Step 3

Carbon filter captures any remaining grease and eliminates odours

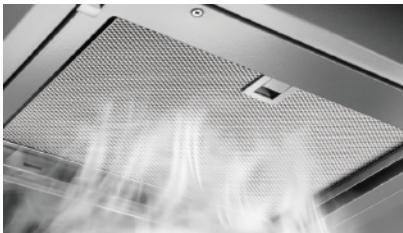

## Miraculous "FRESH-AIR FILTER"

Grease-capturing filter and odour-eliminating carbon filter work together for more effective grease control and odour elimination.

### 1. Powerful grease filtration and odour elimination

- ① After hundreds of tests, the ideal thickness for the carbon filter was determined to be 20mm. This allows for high-efficiency filtration without hindering airflow.
- ② Over 50% activated carbon content increases particle filtration ability while absorbing more fumes.

### 2. Super-long carbon filter replacement cycle

- ① Frontal grease filtration design and centralized grease filtration effectively lowers the ability of grease to adhere to the carbon filter medium. Lifetime use is 3x longer.
- ② 10mm grease layer isolate design ensures that grease dripping from the aluminum mesh cannot stick to the carbon filter. This extends the life of the internal carbon filter.